



# WALL FINISH PROFESSIONALS

**WIN\***  
**RM 1,000!**

Join our photo contest now!  
\*T&C Apply More info: [suzuka.com.my/promotion](http://suzuka.com.my/promotion)



[nuhaus.org](http://nuhaus.org)

[nuhaus\\_brunei](https://www.instagram.com/nuhaus_brunei) | Hotline : +673 730 6870 | 875 9880

\* Photos of the products shown in the brochure are based on the scale of 1:12  
\* May vary in color due to lighting condition and printing.  
We suggest you examine actual product samples before ordering.



BRICK-E9-2308



# KASTONE® BRICK VENEER COLLECTION



EDITION 9



# SUZUKA® | WALL FINISH PROFESSIONALS

SUZUKA® Malaysia belongs to the SUZUKA® Group, which holds manufacturing companies in Taiwan, Malaysia, and Thailand. As one of South East Asia's leading manufacturers in decorative building materials, SUZUKA® Malaysia's expertise in wall finishes dates back to its origins in the town of Suzuka, Japan, after World War II. Specializing in a wide range of stone veneers, waterproofing materials, and textured coatings, we offer durable products that are suitable for decorating and protecting both the interiors and exteriors of your homes and commercial buildings.

Not only do our products cater to buildings of various aesthetics and designs, but they also exceed international quality and safety standards. Armed with protection against UV damage, water seepage, dust, dirt and stains, we lower potential maintenance costs in the future. In addition to being an ISO 9001 certified company, we also carry a selection of SIRIM QAS certified products and a range of environmentally-friendly products certified by Singapore Green Label and SIRIM Eco Label.

Within the past decade, we've become an international supplier to number of regions, including Australia, Saudi Arabia, Thailand, Cambodia, Qatar, the United Arab Emirates, Bahrain, Indonesia, Singapore, and West Africa.

To experience why SUZUKA® products are trusted around the world, choose from our extensive range of coatings and artificial stone veneers.



BRICK & STONE VENEER • TEXTURED PAINT • KASTPANEL • ECES • TEXTURE COATING • PEBBLE STONE COATING

# KASTONE®

KASTONE® products range from classic brick styles to timeless stone designs. Our brick and stone veneer collections showcase a wide variety of colours, shapes, and textures, catering to any interior or exterior space.

KASTONE® veneers are authentic in appearance and feel, as each piece is uniquely crafted to mirror natural stones and bricks. Comprised only of premium raw materials, our veneers' lightweight and durable nature streamlines the installation process while minimizing costs and maintenance work.



Corner Brick

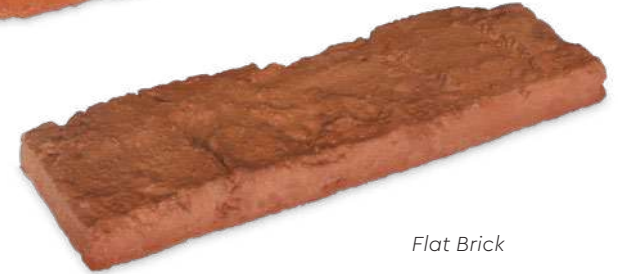

Flat Brick

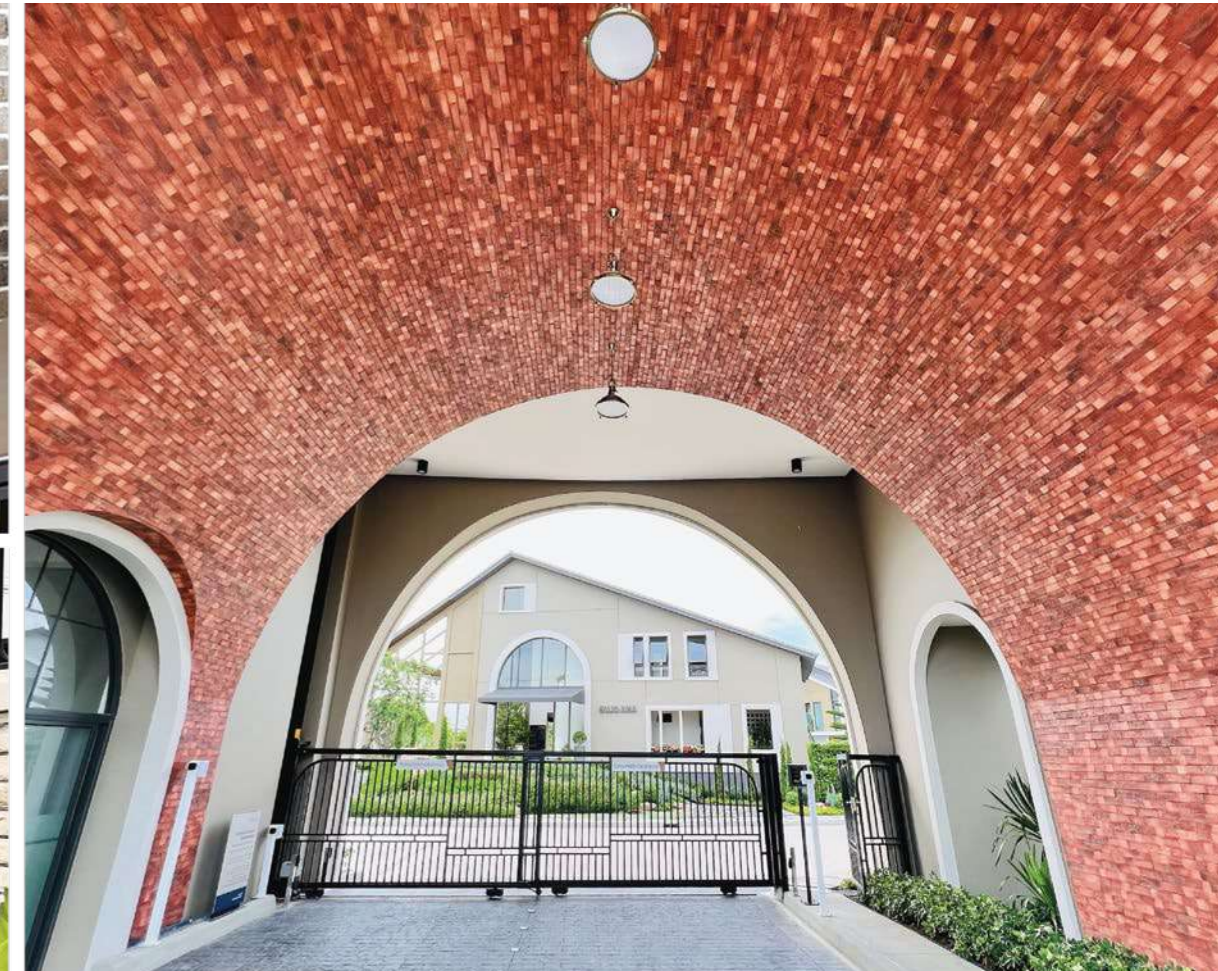



# KASTONE® GROUTING

FOR AN OPTIMAL EFFECT

KASTONE® Grouting is a coloured, cementitious and sand-based grouting that is used to fill and support the joints between stones and bricks during installation. Formulated with coarse silica sand, synthetic resin, colour pigments, and water retentive additives, this durable material is applicable on any dry surface with widths between **4-15 mm**.



### Coverage:

Model Code	Coverage (sqf/kg)	Depth (mm)	Width (mm)
AR-30	3.3 ~ 3.6	3	10
BL-61	3.3 ~ 3.6	3	10
BK-71	2.4 ~ 2.6	6 ~ 7	10
BQ-00	2.3 ~ 2.5	5 ~ 6	10
BK-31	2.4 ~ 2.6	6 ~ 7	10
BK-41	2.5 ~ 2.7	6 ~ 7	10
BK-11/12/13	2.4 ~ 2.6	4 ~ 5	10
DS-90	2.4 ~ 2.6	4 ~ 5	10
DS-50	2.4 ~ 2.6	6 ~ 7	10

### Packing Size:

Weight	Packing
3.5 kg / pack	4 packs / box
1.0 kg / pack	14 packs / box

### Features

-  Suitable for both interiors & exteriors
-  Anti-cracking
-  Water-resistant
-  Available in a variety of colours & textures
-  Compressible & expandable (in accordance with environmental factors)
-  Optimal for the authentic brick wall effect

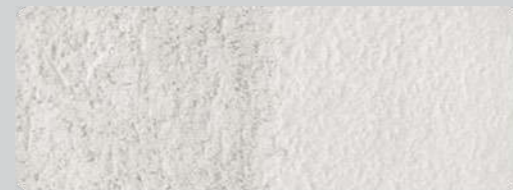

GM-16



GM-11



GM-04



GM-12



GM-03



GM-01







# KASTONE® EASY

## CONSTRUCTION ADHESIVE



KASTONE® EASY - CONSTRUCTION ADHESIVE is an instant grab adhesive sealant based on advanced MS Polymer technology. The instant-grab capability eliminates the need for mechanical support: bracing, nailing, screwing, or other fastening devices.

### Features

-  Instant Grab
-  Primerless
-  Interior & Exterior
-  High Strength
-  Fast & Easy
-  Water Resistant

Ideal for SUZUKA® KASTONE® Brick Veneer.

Product Code	Adhesive Usage Length	Adhesive Coverage per tube (m²)	Holding Time
BK-31	6 cm x 2	0.9	6 sec
BK-11	5 cm x 2	1.0	5 sec
BK-12	5 cm x 2	1.0	6 sec
BK-13	5 cm x 2	1.0	5 sec
DS-90	5 cm x 2	0.9	6 sec
DS-10	3.5 cm x 2	0.9	8 sec
BK-71	6 cm x 2	0.9	6 - 8 sec
AR-30	5 cm x 2	1.2	1 - 3 sec max
BL-61	5 cm x 2	1.2	1 - 3 sec max

**USAGE TIPS:** • Tip cutting: diameter **6 mm** slanting. • Apply & hold veneer on wall for few seconds. Applicable on aluminium, wood, metal, tiles, glass or mirror surface. Ensure the surface is clean.



# SUZUKA® WALL SEALER PRO

“ Make your wall finishes last longer! ”

Superior primer for concrete, skimmed or masonry surfaces.

Packing Size:

- 1L
- 5L
- 20L



This sealer that has good substrate penetration abilities to increase adhesion of product to prevent chalking or peeling off. It has excellent alkaline resistance properties that can prevent efflorescence. It is an ideal base coat for any SUZUKA® or any wall finish products.

Coverage	Drying Time (hour)		Airless Spray
6.5 - 8.5 m²/l/coat	Surface Dry	: 1	Nozzle : 1.8 - 2.0 mm Spray Angle Degree : 65° - 80° Pressure : 210 psi/150kg/cm²
	Hard Dry	: 5	
	Recoating	: 5	
	Substrate Temperature:	23°C - 26°C	

### Suitable for:

- Masonry wall
- Brickwork
- Plaster
- Skimmed Coat
- Asbestos free substrate

### Features:

- Excellent alkaline resistance to prevent efflorescence.
- Good for new walls and repainting.
- Extremely goof penetration.
- Excellent adhesion.
- Exterior and interior use.



# KASTONE<sup>®</sup> AIR

Lightweight, Flexible, Authentic Texture and Easy Installation.

One of the lightest artificial stone veneers. Its semi-flexibility allows application onto curved surfaces (35 cm in diameter and over) without cracking. Its flexibility also allows it to be cut & trimmed with scissors making it ideal for DIY & surfaces with unique shapes & designs.

- **Semi-flexible**
- **5-6mm in thickness**
- **Recommended for DIY**
- **Can be cut / trimmed with scissors**
- **Recommended for curved surfaces & columns.** (35cm in diameter or over)

## RECOMMENDED INSTALLATION DESIGN

- Arrange the stones in a zig zag pattern.
- Arrange the colors/shades randomly and evenly (you may try laying the stones on the floor first).



Please allow a +/- 5% tolerance for stone size and colour

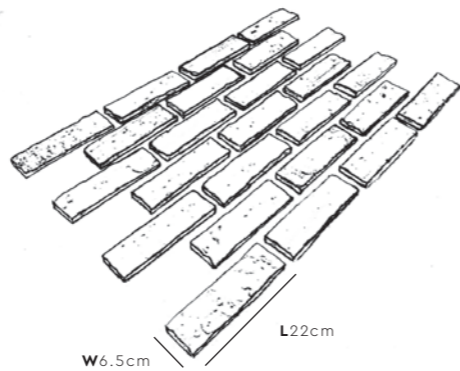

**AR-30** Coverage (Per Box) : 10.5 ~ 10.7 sqf | Weight (Per Box) : 5.5 kg | Pieces (Per Box) : 60 pcs



Scan for more info about this product.

\*May vary in colour due to lighting conditions and printing. Please examine product samples prior to ordering.



# KASTONE<sup>®</sup> Lite

Lightweight, Authentic Texture and Easy Installation.

At a fraction in thickness & weight, it is easy & fast to install, it also gives a more polished & sleek finish for those who are looking for less texture.

- **4-7 mm in thickness.**
- **Recommended for partitions.**
- **Recommended for projects that require fast installation.**

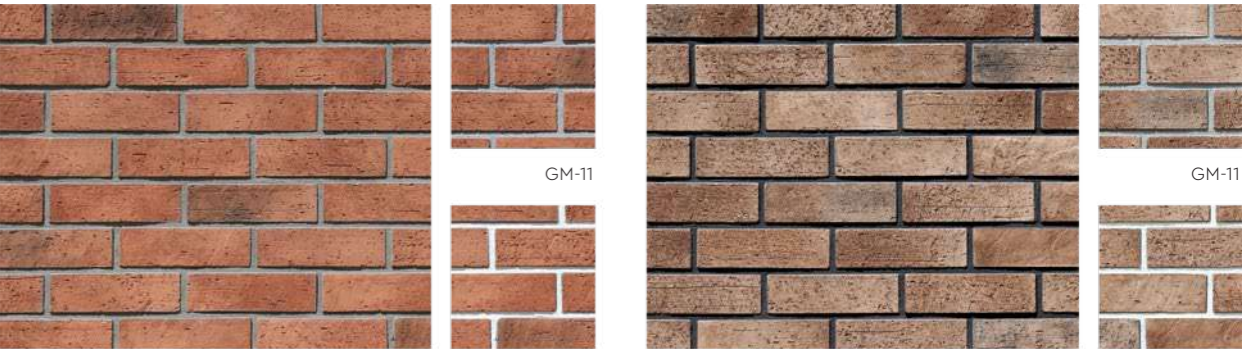

**AR-3001** Grouting GM-12 GM-01 **AR-3002** Grouting GM-11 GM-16



**AR-3003** Grouting GM-16 GM-12 **AR-3004** Grouting GM-12 GM-16



**BL-6101** Grouting GM-12 GM-16 **BL-6104** Grouting GM-01 GM-16



**BL-6106** Grouting GM-16 GM-11 **BL-6108** Grouting GM-12 GM-01

## RECOMMENDED INSTALLATION DESIGN

- Arrange the stones in a zig zag pattern.
- Arrange the colors/shades randomly and evenly (you may try laying the stones on the floor first).



Please allow a +/- 5% tolerance for stone size and colour

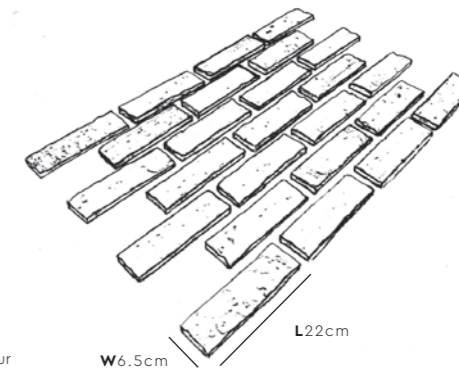

**BL-61** Coverage (Per Box) : 8.4 ~ 8.6 sqf | Weight (Per Box) : 6 kg | Pieces (Per Box) : 46 pcs

For D.I.Y.  
We recommend  
KASTONE<sup>®</sup>  
Easy Adhesive



\*May vary in colour due to lighting conditions and printing. Please examine product samples prior to ordering.

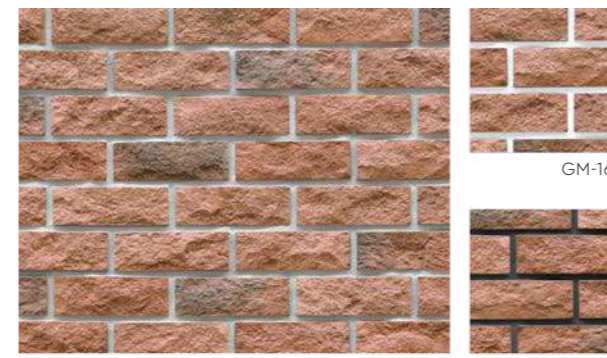

**BK-7101** Grouting GM-11 GM-01

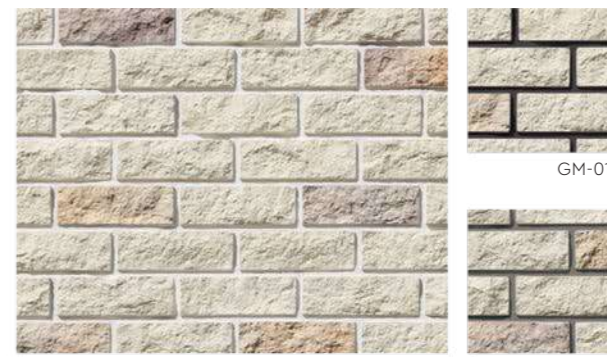

**BK-7102** Grouting GM-16 GM-12

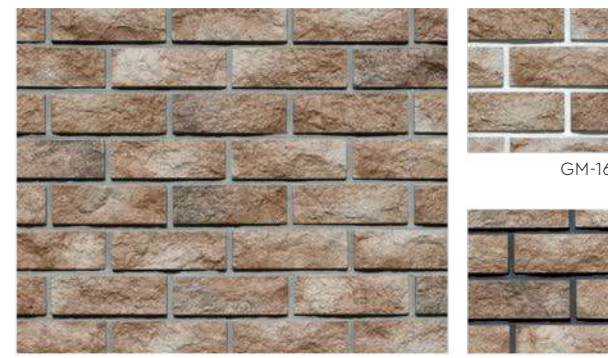

**BK-7104** Grouting GM-12 GM-01



**BK-7105** Grouting GM-11 GM-01

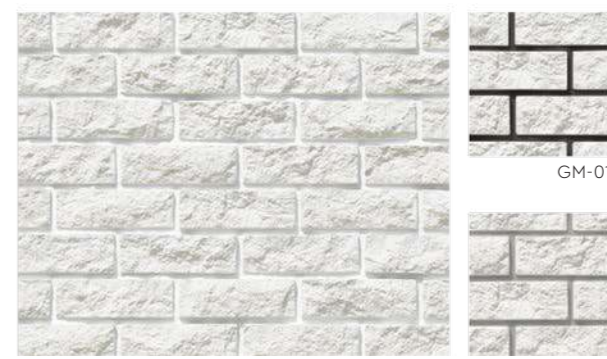

**BK-7106** Grouting GM-16 GM-01

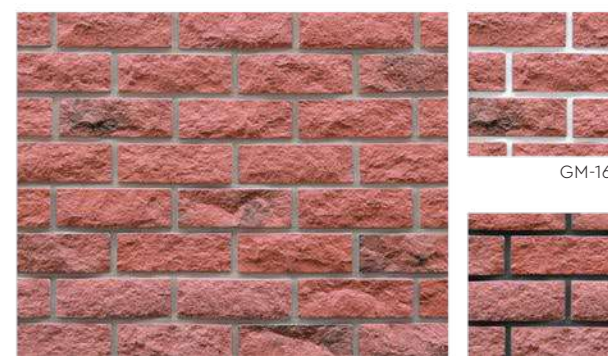

**BK-7108** Grouting GM-12 GM-01

### RECOMMENDED INSTALLATION DESIGN

- Arrange the stones in a zig zag pattern.
- Arrange the colors/shades randomly and evenly (you may try laying the stones on the floor first).



Please allow a +/- 5% tolerance for stone size and colour

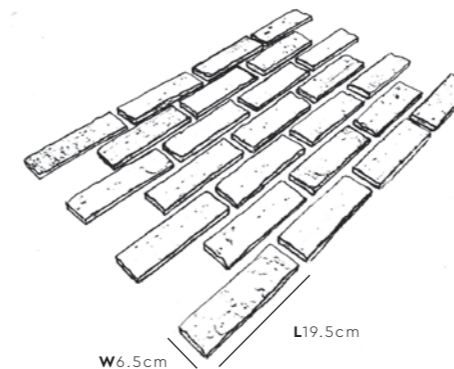

**BK-71** Coverage (Per Box) : **8.9 ~ 9.1 sqf** | Weight (Per Box) : **21.3 kg** | Pieces (Per Box) : **55 pcs**



BQ-001 Grouting GM-16 GM-01



BQ-002 Grouting GM-11 GM-16



BQ-003 Grouting GM-12 GM-01

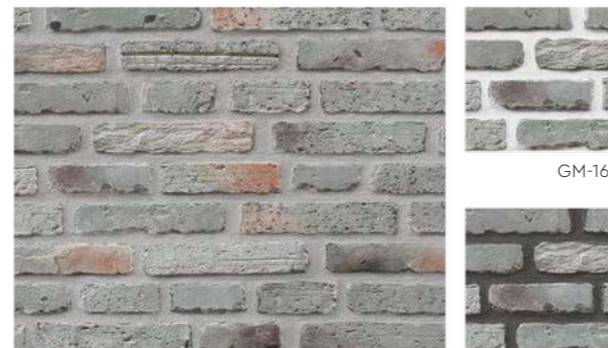

BQ-004 Grouting GM-11 GM-01

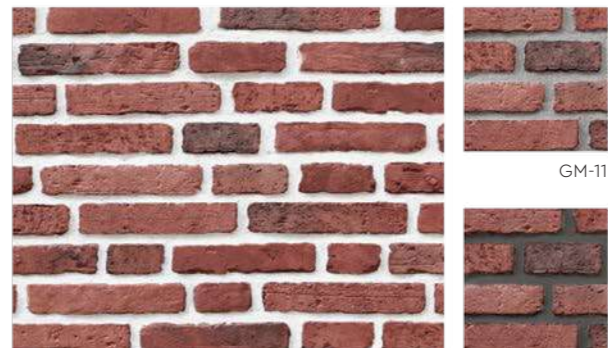

BQ-005 Grouting GM-16 GM-01



BQ-006 Grouting GM-01 GM-11



**RECOMMENDED INSTALLATION DESIGN**

- Arrange the colors/shades randomly and evenly (you may try laying the stones on the floor first).



Please allow a +/- 5% tolerance for stone size and colour

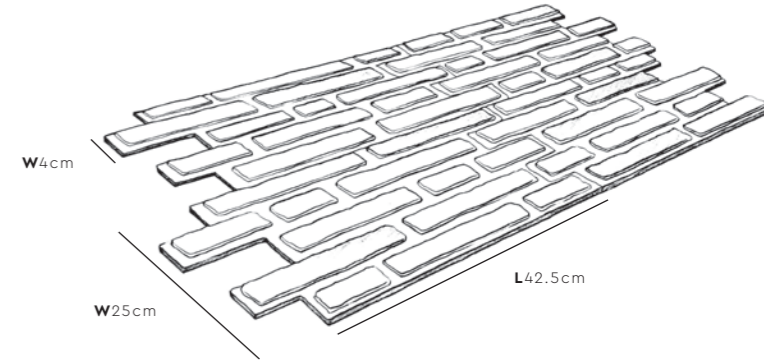

**BQ-00** Coverage (Per Box) : 9.0 ~ 9.2 sqf | Weight (Per Box) : 16 kg | Pieces (Per Box) : 8 pcs

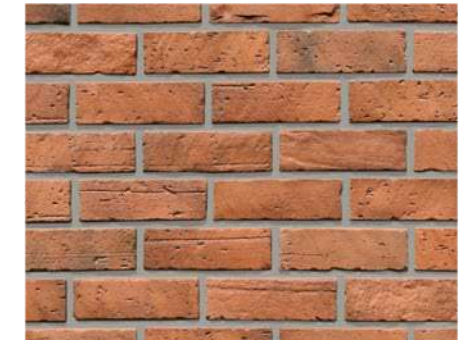
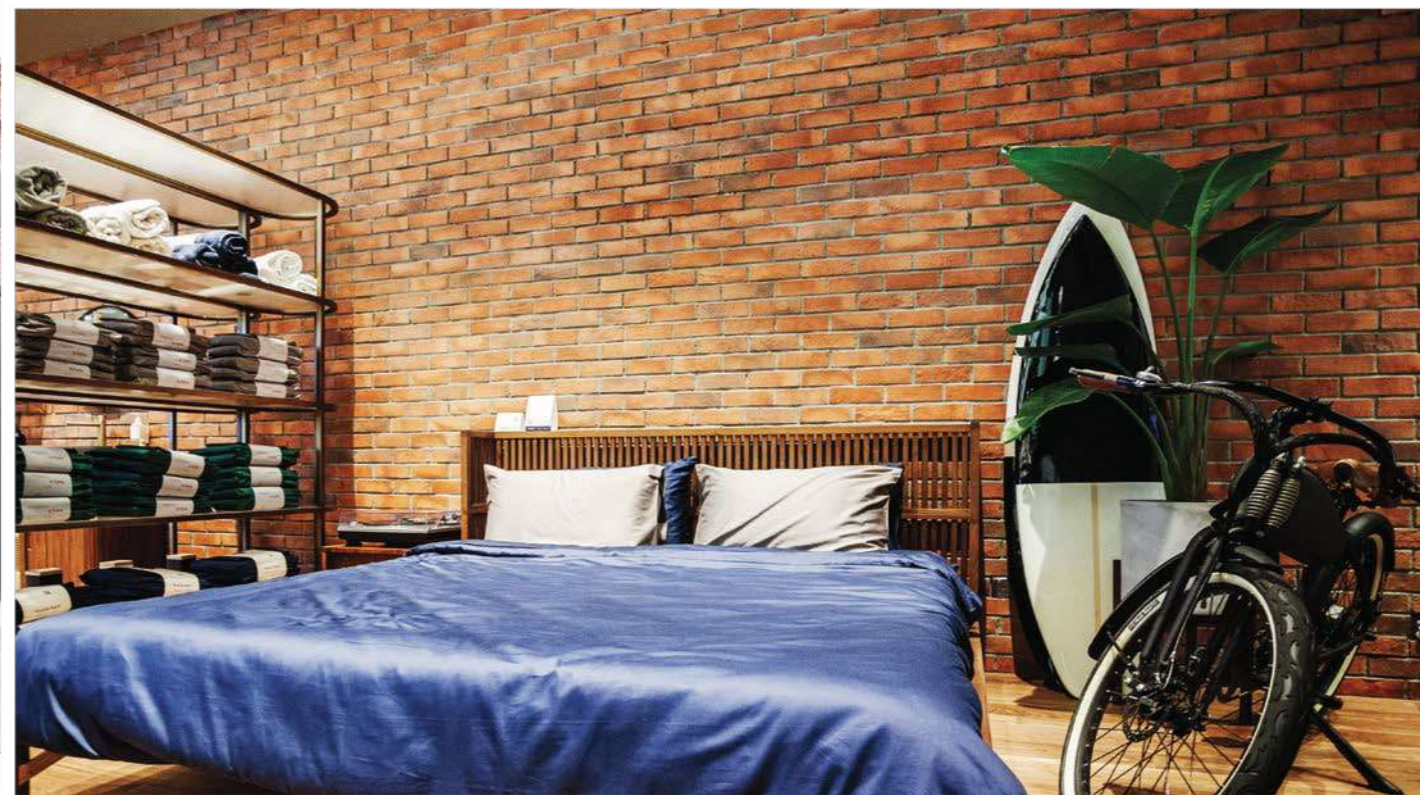

BK-3101

Grouting GM-12



GM-16

GM-01



BK-3102

Grouting GM-16



GM-01

GM-12



BK-3104

Grouting GM-11



GM-16

GM-01

\*May vary in colour due to lighting conditions and printing. Please examine product samples prior to ordering.

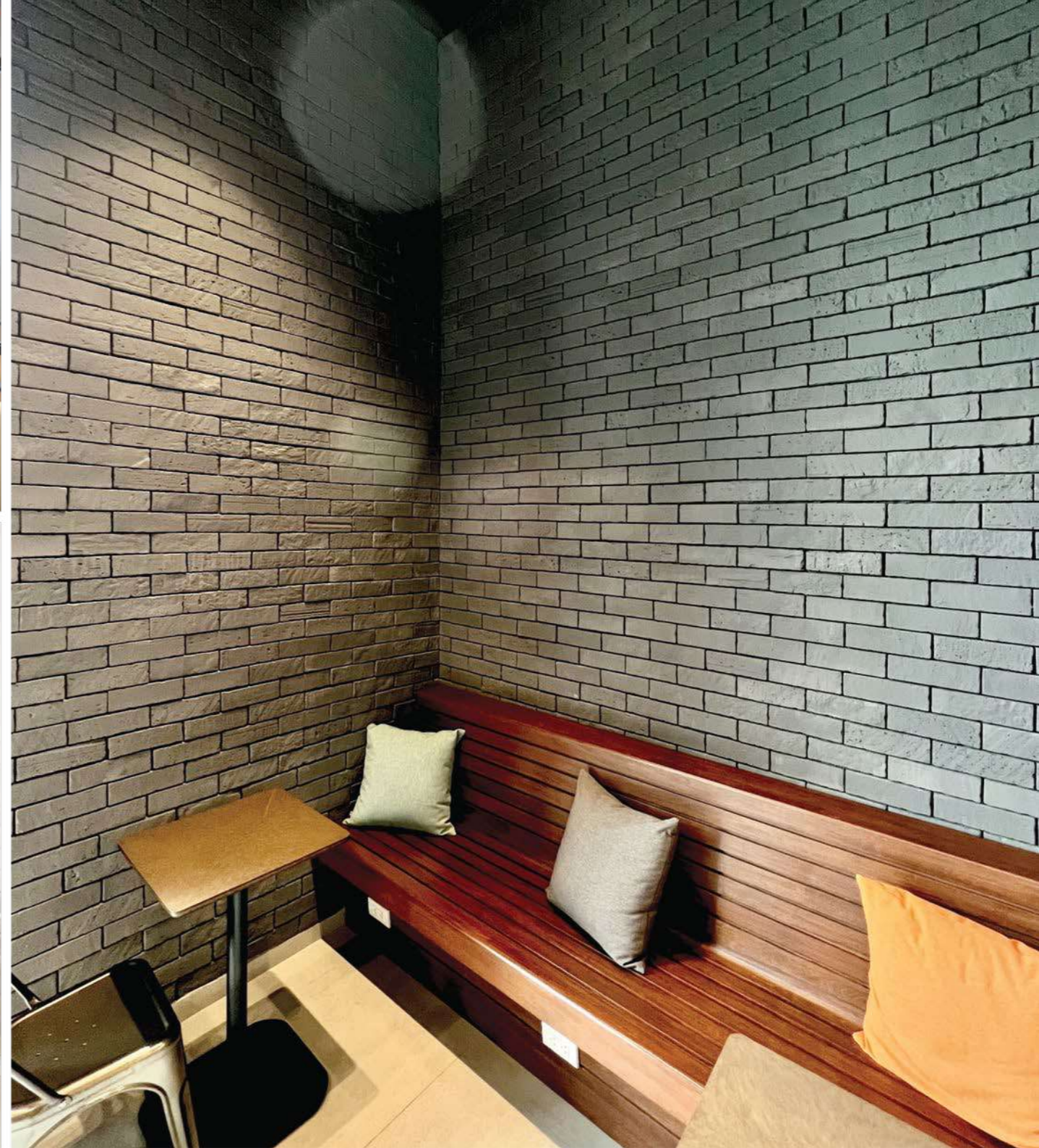

BK-3105

Grouting GM-11



GM-16

GM-01



BK-3106

Grouting GM-16



GM-01

GM-11



BK-3107

Grouting GM-12



GM-16

GM-01

\*May vary in colour due to lighting conditions and printing. Please examine product samples prior to ordering.





**BK-3108** Grouting GM-16 GM-12 GM-01 **BK-3109** Grouting GM-01 GM-16



**BK-3110** Grouting GM-12 GM-01 **BK-3111** Grouting GM-11 GM-01

### RECOMMENDED INSTALLATION DESIGN

- Arrange the stones in a zig zag pattern.
- Arrange the colors/shades randomly and evenly (you may try laying the stones on the floor first).

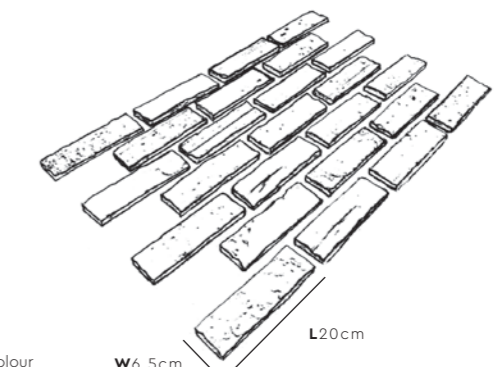

Please allow a +/- 5% tolerance for stone size and colour

<b>BK-31</b>	Flat Brick	Coverage (Per Box) : 8.4 ~ 8.6 sqf	Weight (Per Box) : 14 kg	Pieces (Per Box) : 48 pcs
	Corner Brick	Coverage (Per Box) : 5.0 ~ 5.2 f	Weight (Per Box) : 10 kg	Pieces (Per Box) : 21 pcs

\*May vary in colour due to lighting conditions and printing. Please examine product samples prior to ordering.



**BK-4101** Grouting GM-11 GM-01



**BK-4102** Grouting GM-16 GM-01



**BK-4104** Grouting GM-01 GM-11



**BK-4105** Grouting GM-12 GM-01



**BK-4106** Grouting GM-16 GM-01



**RECOMMENDED INSTALLATION DESIGN**

- Arrange the stones in a zig zag pattern.
- Arrange the colors/shades randomly and evenly (you may try laying the stones on the floor first).



Please allow a +/- 5% tolerance for stone size and colour

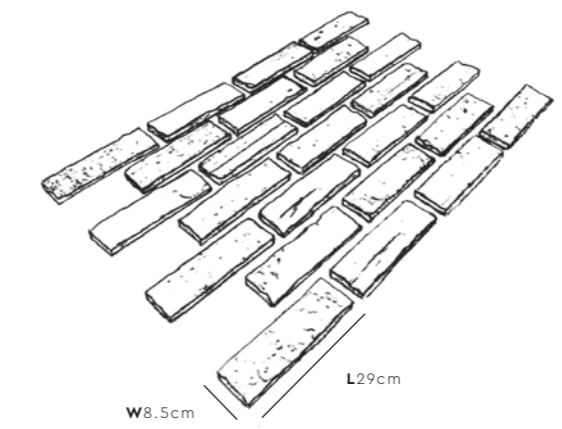

<b>BK-41</b>	Flat Brick	Coverage (Per Box) : 9.0 ~ 9.2 sqf	Weight (Per Box) : 20 kg	Pieces (Per Box) : 30 pcs
	Corner Brick	Coverage (Per Box) : 4.8 ~ 5.1 f	Weight (Per Box) : 13 kg	Pieces (Per Box) : 16 pcs

\*May vary in colour due to lighting conditions and printing. Please examine product samples prior to ordering.

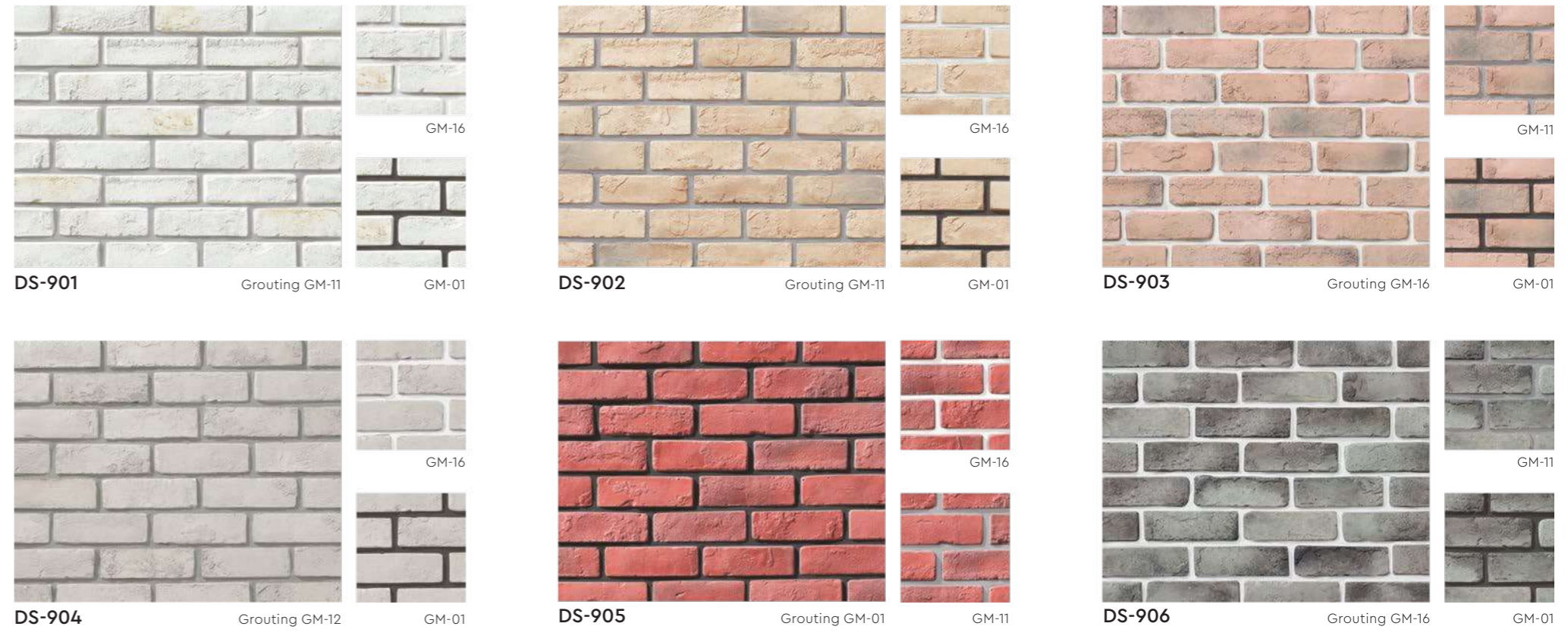

### RECOMMENDED INSTALLATION DESIGN

- Arrange the stones in a zig zag pattern.
- Arrange the colors/shades randomly and evenly (you may try laying the stones on the floor first).



Please allow a +/- 5% tolerance for stone size and colour

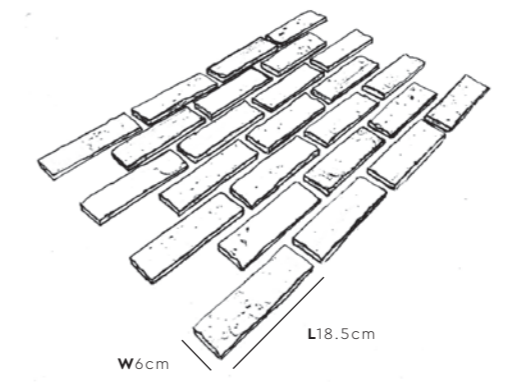

<b>DS-90</b>	Flat Brick	Coverage (Per Box) : 12.9 ~ 13.4 sqf	Weight (Per Box) : 24 kg	Pieces (Per Box) : 96 pcs
	Corner Brick	Coverage (Per Box) : 8.7 ~ 8.9 f	Weight (Per Box) : 15.3 kg	Pieces (Per Box) : 30 pcs

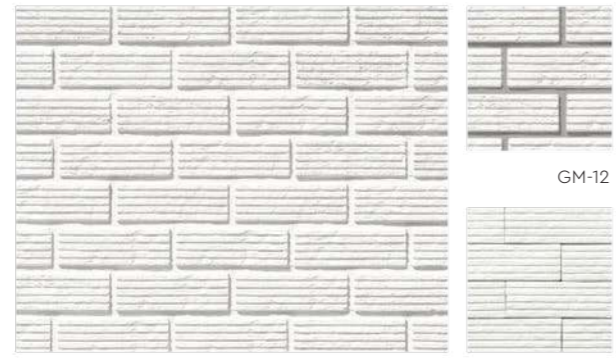

**BK-1101** Grouting GM-16 Without Grouting

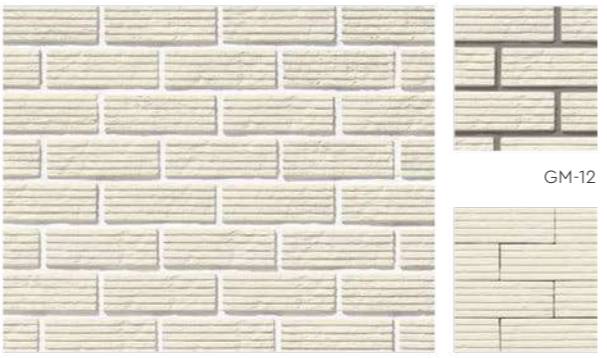

**BK-1102** Grouting GM-16 Without Grouting

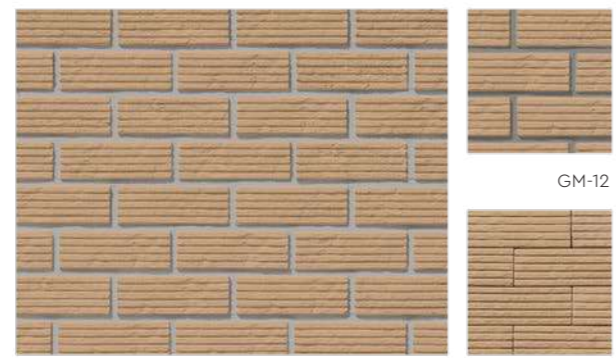

**BK-1103** Grouting GM-11 Without Grouting

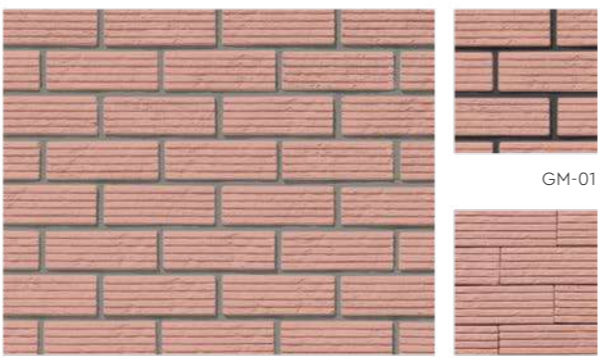

**BK-1104** Grouting GM-12 Without Grouting

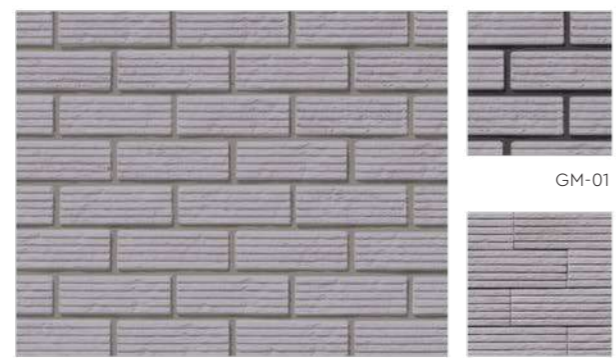

**BK-1105** Grouting GM-12 Without Grouting

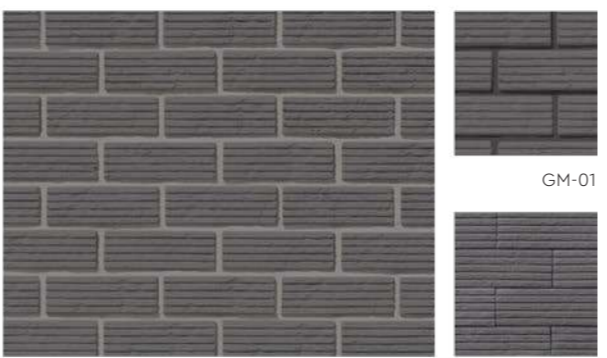

**BK-1106** Grouting GM-12 Without Grouting

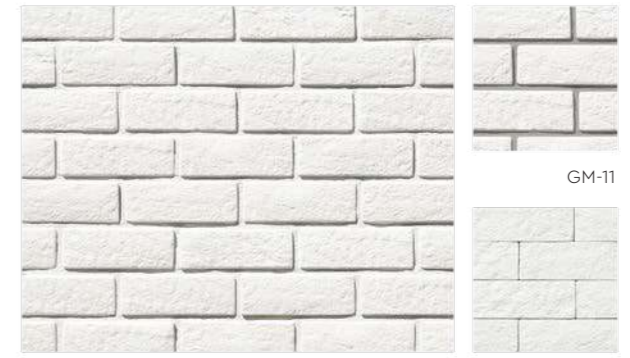

**BK-1201** Grouting GM-16 Without Grouting

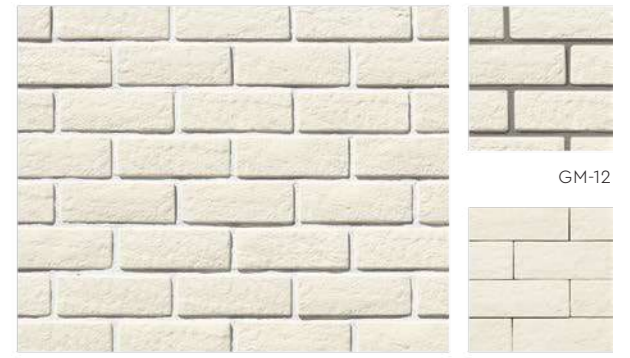

**BK-1202** Grouting GM-16 Without Grouting

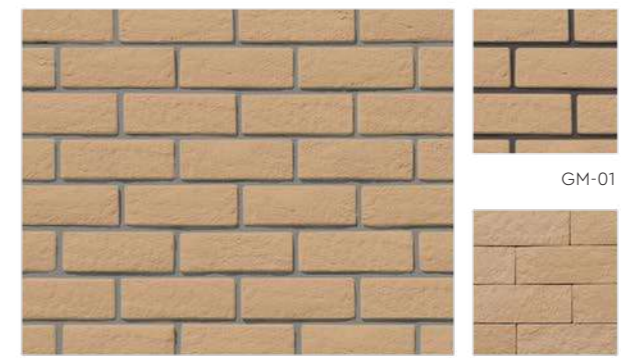

**BK-1203** Grouting GM-12 Without Grouting

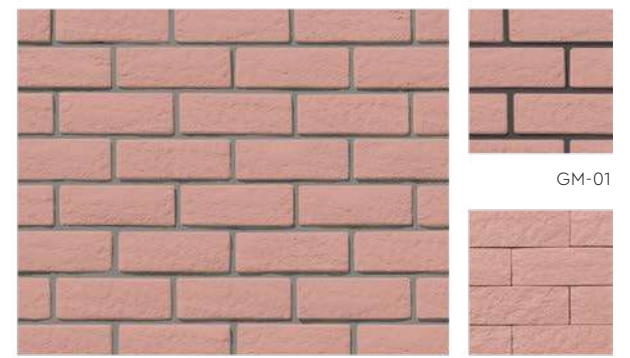

**BK-1204** Grouting GM-12 Without Grouting

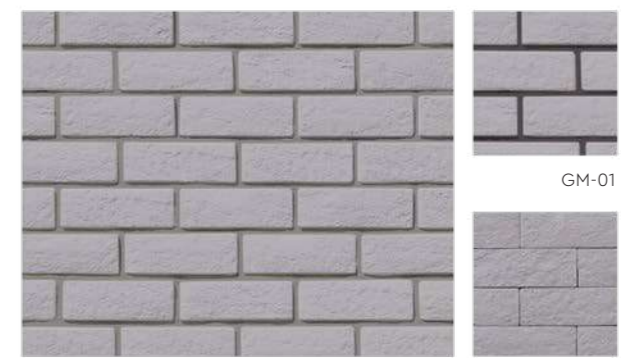

**BK-1205** Grouting GM-12 Without Grouting

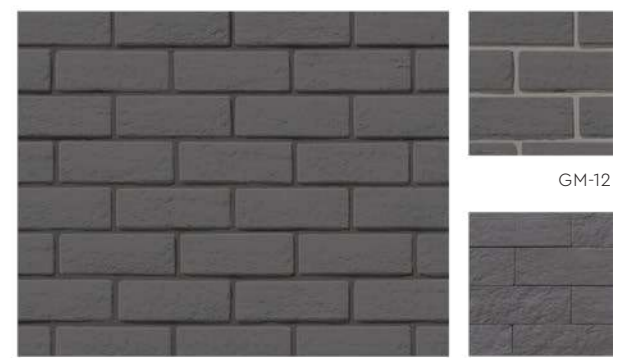

**BK-1206** Grouting GM-01 Without Grouting

\*May vary in colour due to lighting conditions and printing. Please examine product samples prior to ordering.

\*May vary in colour due to lighting conditions and printing. Please examine product samples prior to ordering.

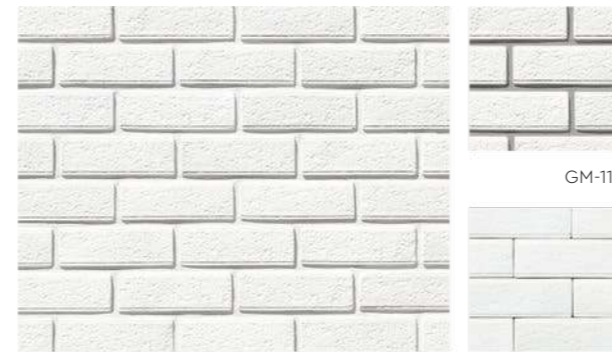

**BK-1301** Grouting GM-16 Without Grouting

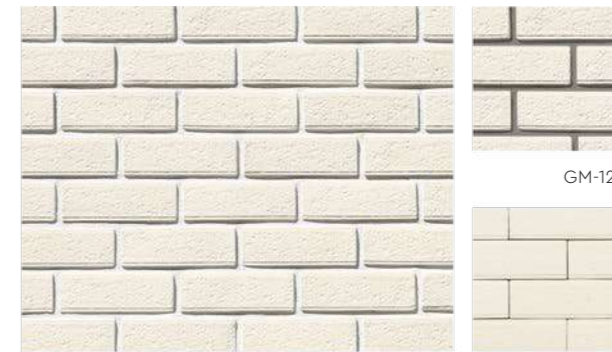

**BK-1302** Grouting GM-16 Without Grouting

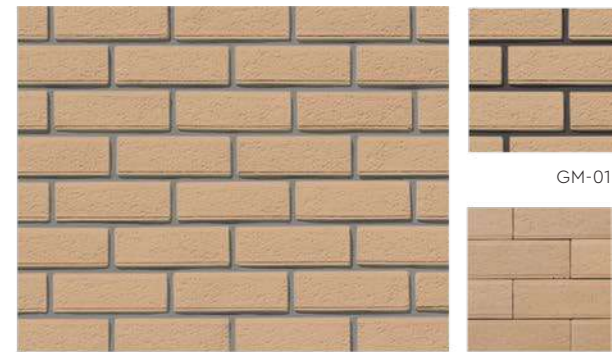

**BK-1303** Grouting GM-12 Without Grouting

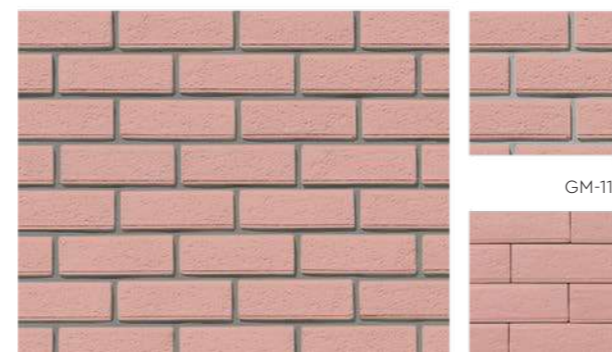

**BK-1304** Grouting GM-12 Without Grouting

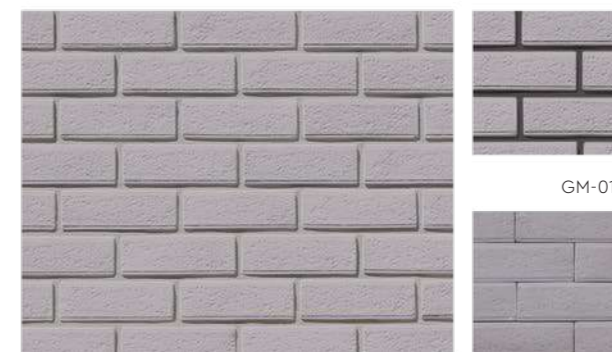

**BK-1305** Grouting GM-11 Without Grouting

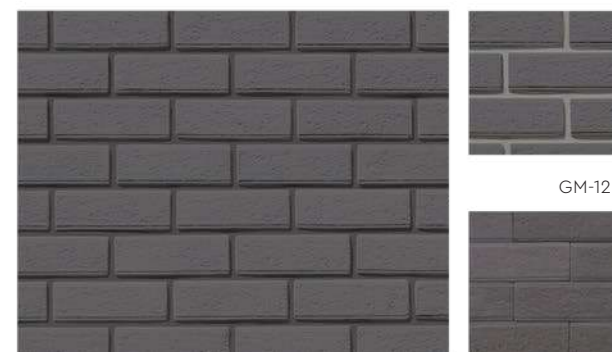

**BK-1306** Grouting GM-01 Without Grouting

### RECOMMENDED INSTALLATION DESIGN

- Arrange the stones in a zig zag pattern.
- Arrange the colors/shades randomly and evenly (you may try laying the stones on the floor first).



Please allow a +/- 5% tolerance for stone size and colour

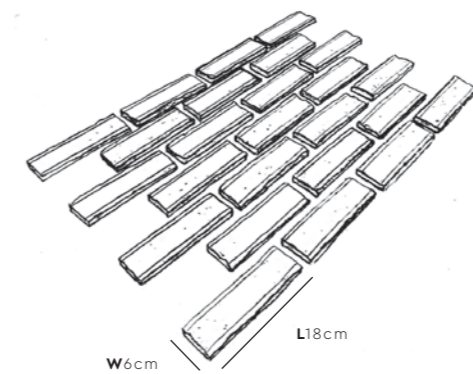

**BK-11/12/13** Coverage (Per Box) : **14.6 ~ 14.8 sqf** (with grouting) / **11.8 ~ 12.1 sqf** (without grouting) | Weight (Per Box) : **21 kg** | Pieces (Per Box) : **104 pcs**



DS-101



DS-102



DS-103



DS-104

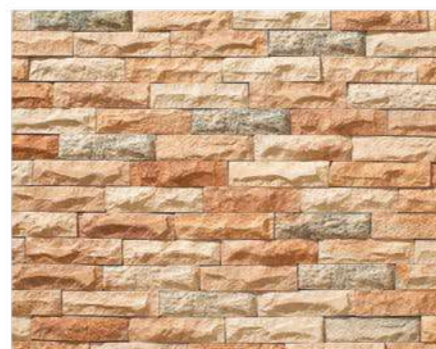

DS-105



DS-106



DS-501



DS-502



DS-503



DS-504 (with grouting)



DS-505 (with grouting)

## RECOMMENDED INSTALLATION DESIGN

- Arrange the stones in a zig zag pattern.
- Arrange the colors/shades randomly and evenly (you may try laying the stones on the floor first).

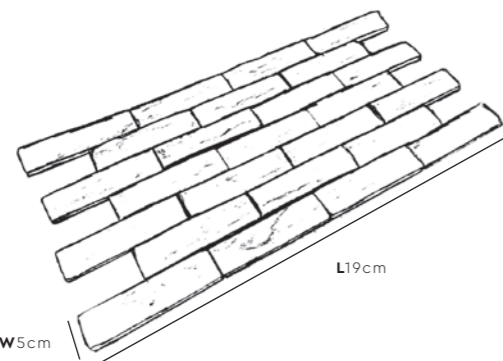

Please allow a +/- 5% tolerance for stone size and colour

<b>DS-10</b>	Flat Brick	Coverage (Per Box) : 10.2 ~ 10.7 sqf	Weight (Per Box) : 25 kg	Pieces (Per Box) : 110 pcs
	Corner Brick	Coverage (Per Box) : 9.0 ~ 9.2 f	Weight (Per Box) : 17 kg	Pieces (Per Box) : 56 pcs

## RECOMMENDED INSTALLATION DESIGN

- Arrange the stones in a zig zag pattern.
- Arrange the colors/shades randomly and evenly (you may try laying the stones on the floor first).

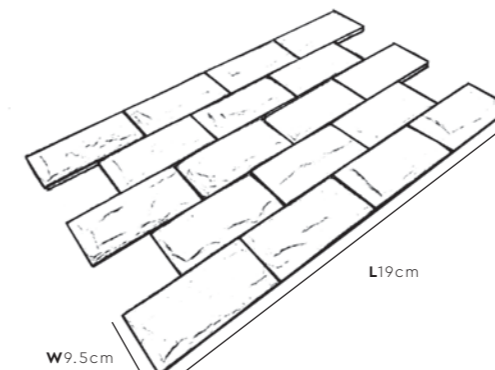

Please allow a +/- 5% tolerance for stone size and colour

<b>DS-50</b>	Flat Brick	Coverage (Per Box) : 12.4 ~ 12.8 sqf	Weight (Per Box) : 28 kg	Pieces (Per Box) : 60 pcs
	Corner Brick	Coverage (Per Box) : 9.0 ~ 9.2 f	Weight (Per Box) : 26 kg	Pieces (Per Box) : 32 pcs

# KASTONE® Topcoat Stone Care

Topcoat for stone & other masonry surfaces for extra protection and durability.



## High Gloss Finish:

An acrylic solvent-based topcoat allowing colour-enhancement and a glossy finish.

## Natural Finish:

An environmentally-friendly water-based topcoat that maintains the original color.

## Coverage & Packing:

High Gloss			Natural		
1L	4L	18L	1L	5L	18L
75 ~ 108sqf	301 ~ 431sqf	1,356 ~ 1,938sqf	75 ~ 108sqf	377 ~ 538sqf	1,356 ~ 1,938sqf

## Suitable for:

- SUZUKA® KASTONE® & Trowel Stone
- Concrete Imprint
- Pebble Wash
- Bricks
- Natural Stone
- Stone / Brick Veneer

\* Not recommended for pre-sealed surfaces or non-porous surfaces, such as ceramic tile, marble, granite, porcelain and terrazzo.

## Features



Easy Application



UV Resistance



Long Lasting & High Endurance



High Adhesion



Water, Algae & Fungus Resistance



Stain Resistance & Easy Cleaning

## Corner Brick



Application with  
Corner Brick

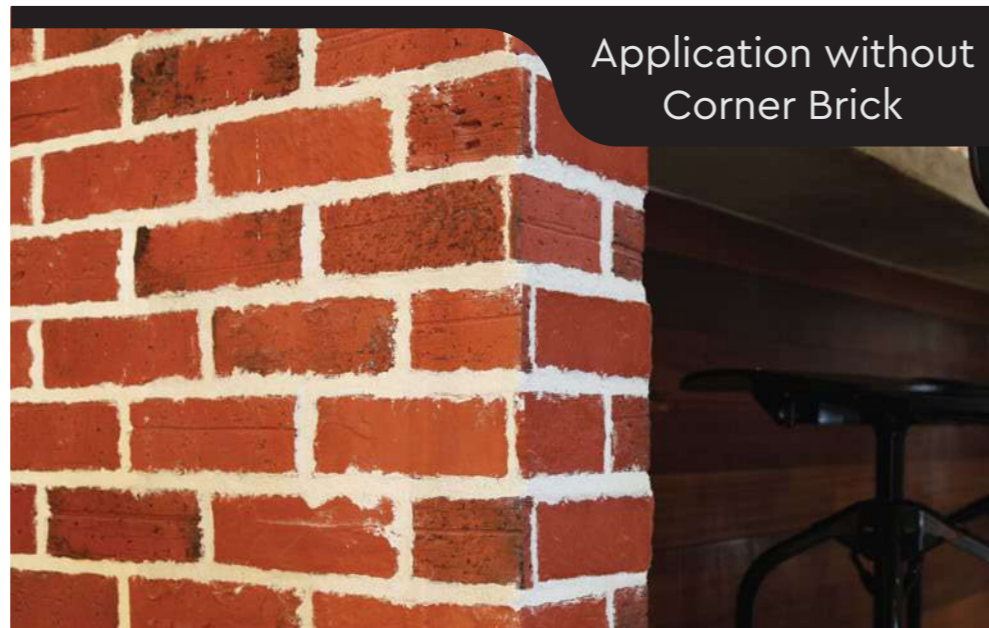

Application without  
Corner Brick

## Brick Patterns

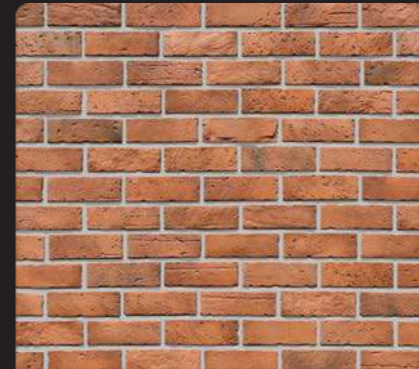

Running Bond



Herringbone

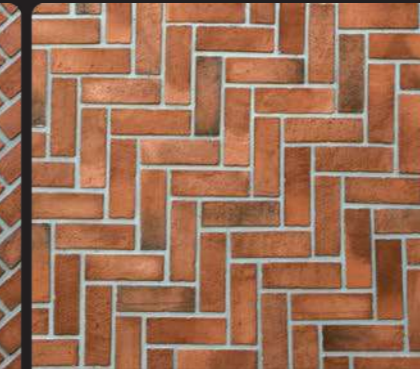

90° Herringbone

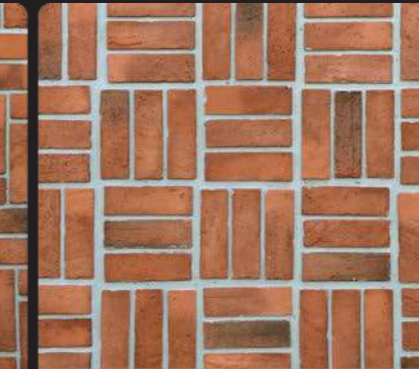

Mosaic

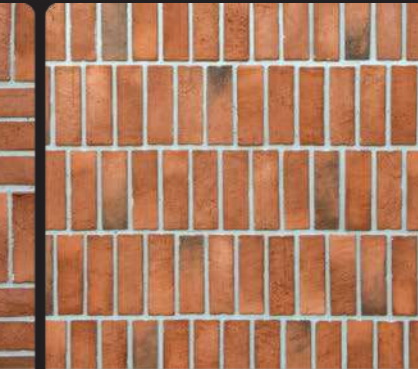

Vertical Stack

## Grouting Techniques

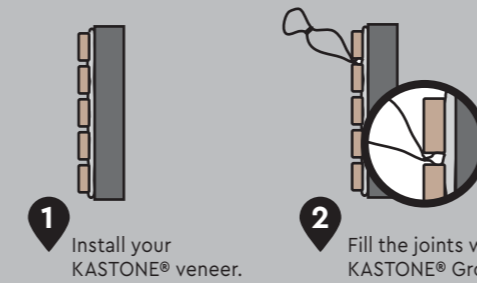

3 Choose your preferred grouting style or finishing.

### A. Standard Grouting



Half height

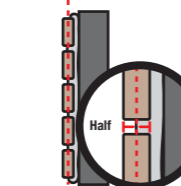

1 Ensure the grouting level reaches half the height of the bricks.

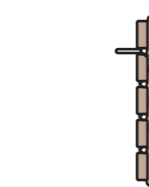

2 Flatten the grouting with a stick.

### B. Full Grouting



Full height

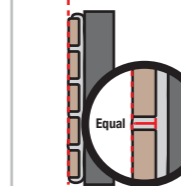

1 Ensure the grouting level reaches the height of the bricks.

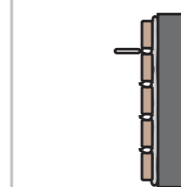

2 Flatten the grouting with a stick.

### C. Over Grouting



Slightly over the height

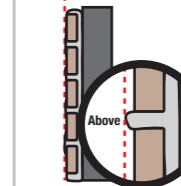

1 Ensure the grouting level protrudes slightly over the height of the bricks.

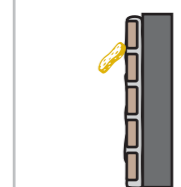

2 Use a sponge to smear the excess grouting across the edges of the bricks' surfaces.

### D. Weep Grouting



Slightly over the height

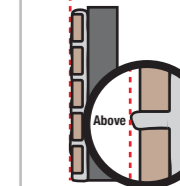

1 Ensure the grouting level protrudes slightly over the height of the bricks.



2 Use a sponge to smear the excess grouting across the edges of the bricks' surfaces.

# KASTONE® Installation



## Step 1 - Wall Surface Preparation

- Hack uniformly across the wall (using a small axe, drill, or hammer) to create a rough and pitted texture on the surface.
- Clean the surface to ensure it is free from dirt and dust.

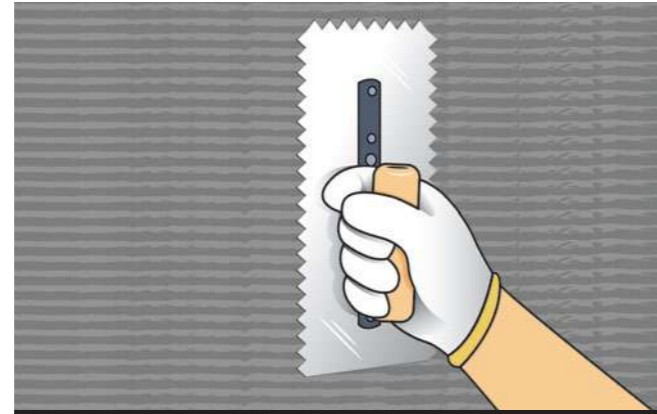

## Step 2 - Mortar Application

Apply a generous layer of mortar across the wall using the notched edge of a trowel, creating a "combed" surface pattern.

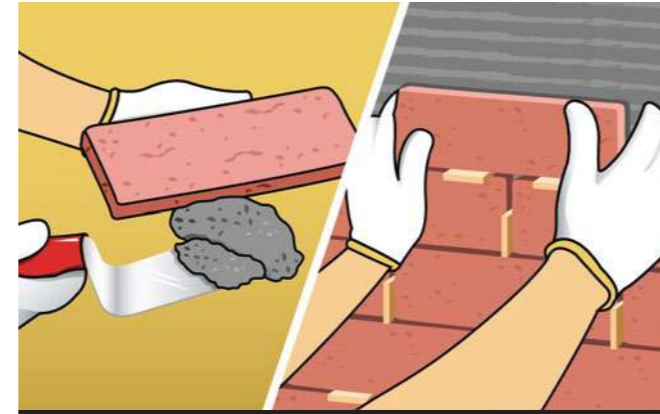

## Step 3 - Stone Application

Complete this step starting from the bottom of the wall & moving upwards: Apply a thick layer of mortar onto the back side of a stone. Press the stone firmly onto the mortared wall surface, holding for a few seconds. Repeat this until the section is completed with stones. Use spacers if necessary to ensure a level arrangement.

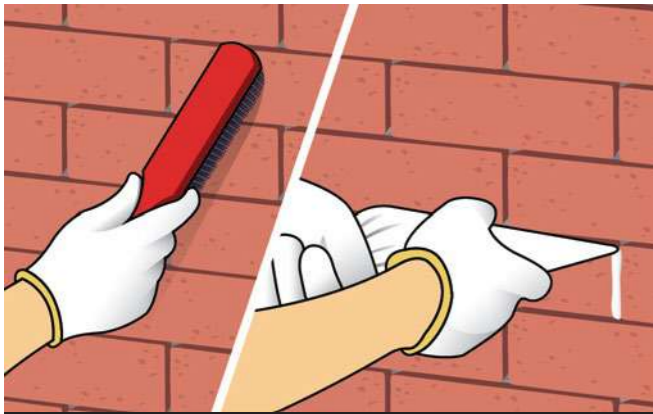

## Step 4 - Grouting Application

- Once the stones are firmly affixed, clean the surface with a dry brush to clear the stones of any dust.
- Using a piping bag, apply KASTONE® Grouting between the joints. See the KASTONE® Grouting instructions for application details. Let dry.

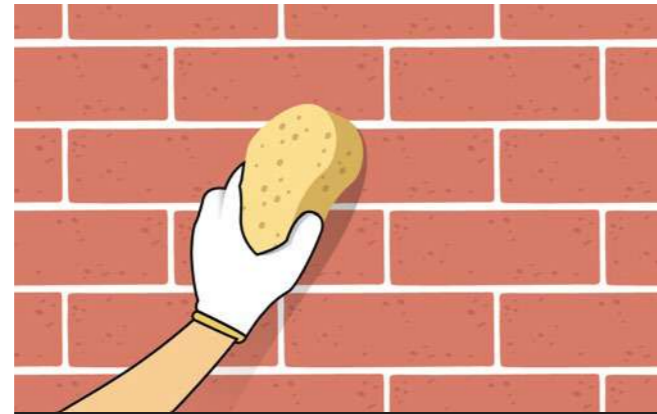

## Step 5 - Cleaning Up

Wipe the surface with a damp cloth or sponge.

Scan QR code to watch installation video online.



# Brick Layout Options

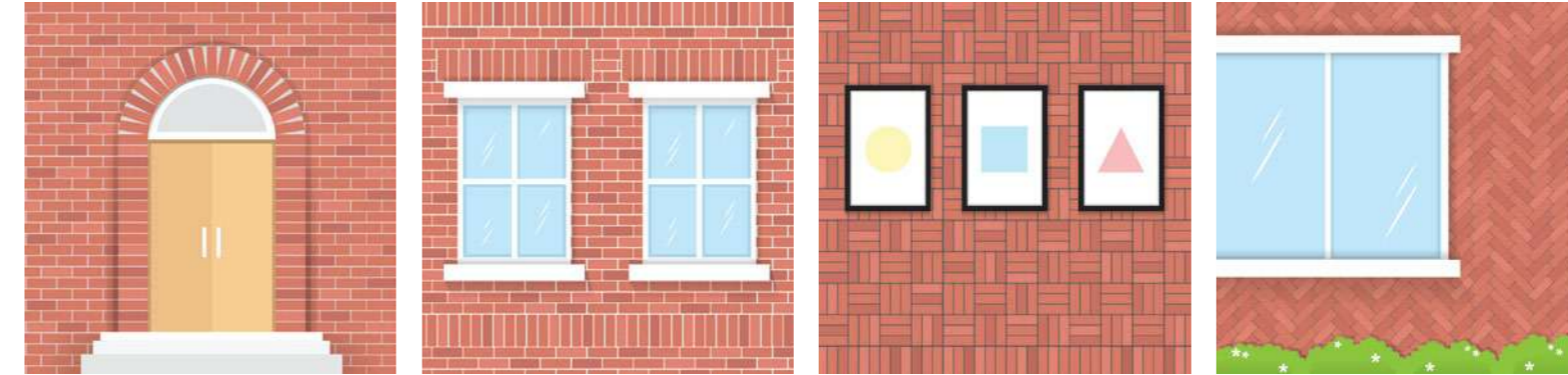

## Calculation of Wall Coverage:

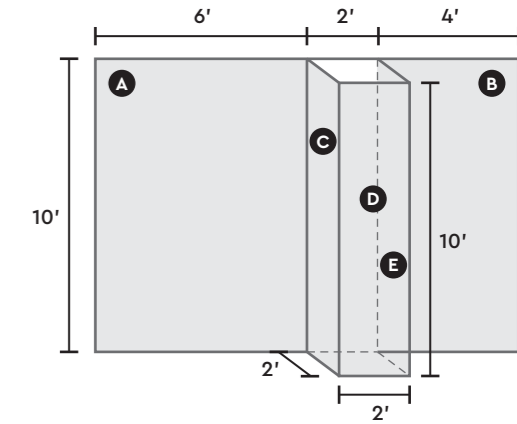

### Surface Dimension:

- A = 10' x 6' = 60 sqf
- B = 10' x 4' = 40 sqf
- C = 10' x 2' = 20 sqf
- D = 10' x 2' = 20 sqf
- E = 10' x 2' = 20 sqf

**Total = 160 sqf**

### Example for BK-31 Series:

Flat = 160sqf - 2(10') (height of corners)  
 = 140sqf / 8.4' (coverage per box)  
**= 17 boxes** (estimate total box)

Corner = 2(10') / 5.0' (coverage per box)  
**= 4 boxes** (estimate total box)



# KASTONE® Packaging Data

MODEL	FLAT BRICK				CORNER BRICK					
	DIMENSIONS (cm)	COVERAGE PER BOX (sqf)	WEIGHT PER BOX (kg)	PIECES PER BOX	DIMENSIONS (cm)	COVERAGE PER BOX (sqf)	WEIGHT PER BOX (kg)	PIECES PER BOX	BOXES/PALLET (Flat/Corner)	M <sup>3</sup> /PALLET (Flat/Corner)
AR-30 Series	W6.5 x L22	10.5 ~ 10.7	5.5	60	-	-	-	-	144/-	1.20 / -
BL-61 Series	W6.5 x L22	8.4 ~ 8.6	6	46	-	-	-	-	120/-	1.20 / -
BK-71 Series	W6.5 x L19.5	8.9 ~ 9.1	21.3	55	-	-	-	-	48/-	1.20 / -
BQ-00 Series	W25 x L42.5	9.0 ~ 9.2	16	8	-	-	-	-	48/-	1.20 / -
BK-41 Series	W8.5 x L29	9.0 ~ 9.2	20	30	W8.5 x S10 x L24.5	4.8 ~ 5.1	13	16	48/48	1.08 / 1.20
BK-31 Series	W6.5 x L20	8.4 ~ 8.6	14	48	W6.5 x S10 x L20	5.0 ~ 5.2	10	21	64/64	1.11 / 1.11
BK-11/12/13 Series	W6 x L18	14.6 ~ 14.8	21	104	-	-	-	-	48/-	1.20 / -
BK-11/12/13 Series (Without grouting)	W6 x L18	11.8 ~ 12.1	21	104	-	-	-	-	48/-	1.20 / -
DS-90 Series	W6 x L18.5	12.9 ~ 13.4	24	96	W6 x S9.5 x L19	8.7 ~ 8.9	15.3	30	40/40	1.13 / 1.13
DS-50 Series	W9.5 x L19	12.4 ~ 12.8	28	60	W9.5 x S7 x L18	9.0 ~ 9.2	26	32	32/32	1.00 / 1.00
DS-10 Series	W5 x L19	10.2 ~ 10.7	25	110	W5 x S10 x L20	9.0 ~ 9.2	17	56	32/32	1.00 / 1.00

Notes: Coverage for the BK-11/12/13, BK-31, BK-41, BK-71, BL-61, AR-30, BQ-00, DS-90 & DS-50 series are inclusive of grouting application. Please allow a +/- 5% tolerance for stone size and colour.